

PROJECT **TYPE**

SINGLE BIN +30K

LIGHTSTRIP, EXTRUSION, & LENS

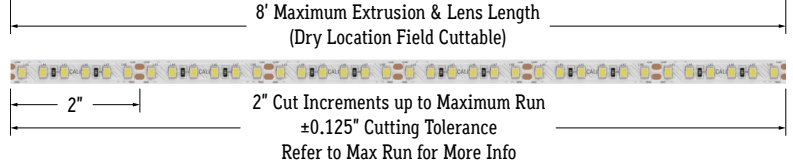

LENS

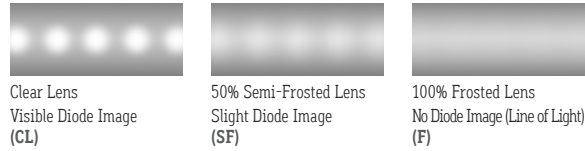

END VIEW

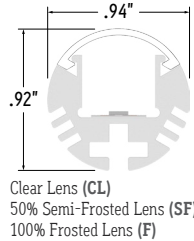

LIGHT LOSS FACTORS

LENS	EFFICACY LOSS
Clear (CL)	0%
50% Semi-Frosted (SF)	12.5%
100% Frosted (F)	25%

Example: 3.0K CCT LED with Frosted Lens. 25% of 100 is 25. 100 - 25 = 75. The Efficacy of 3.0K CCT LED with Frosted Lens is 75.

FEATURES

APPLICATIONS	Accent, Decorative, Surface, Recessed, Pendant Lighting
LAMP TYPE	LEDs
CRI	> 95
LENS	Clear, 50% Semi-Frosted, or 100% Frosted
VIEWING ANGLE	120°
MOUNTING	Mounting Brackets (Sold Separately)
WEIGHT	0.378 lbs per foot
CONSTRUCTION	Aluminum Extrusion
LENGTH	Built to Order
LISTING	Dry, Wet, or IP67 Location UL2108, CSA C22.2 #9 UL8750, CSA250
INSTALLATION	Link to Installation Instructions
ELECTRICAL	
DIMMING	Forward / Reverse Phase, 0-10V, Lutron, DMX, DALI
MAXIMUM RUN (Based on 5 Amps)	18' (6.5W), 21' (5.5W), 26' (4.5W), 33' (3.6W), 36' (1.5W, 2.5W)
MAXIMUM RUN (Based on 4 Amps for Class II)	14' (6.5W), 17' (5.5W), 21' (4.5W), 26' (3.6W), 36' (1.5W, 2.5W)
VOLTAGE	24VDC
DRIVER	Remote (Sold Separately)
TEMPERATURE RATINGS	Operating / Startup: -20° to 48°C (-4° to 120°F) Storage: -40° to 76°C (-40° to 170°F)

SERIES	LENS / OPTICS	WATTS PER FOOT	DIMMING	CCT LED	LISTING	FINISH	FIXTURE LENGTH
LLED8000-RPM	-	-	-	-	-	-	-
LLED8000-RPM	Clear Lens (CL)	1.5 Watts (1.5W) 2.5 Watts (2.5W)	Forward / Reverse Phase (PH) 0-10V: 100% - 1% (10V)	2400K (2.4K) 2700K (2.7K)	Indoor (DRY)	Natural Silver* ¹ (NA) Polished (PA)	Specify Length in Feet & Inches Example: 7'8"
	50% Semi-Frosted Lens (SF)	3.6 Watts (3.6W) 4.5 Watts (4.5W)	Hi-Lume 1% 2 Wire* ² (LTEA) Hi-Lume 1% 3 Wire* ³ (L3DA)	3000K (3.0K) 3500K (3.5K)	Outdoor* ⁸ (WET)	White (WH) Satin / Silver (SA)	
	100% Frosted Lens: Line of Light (F)	5.5 Watts (5.5W) 6.5 Watts (6.5W)	Hi-Lume Premier 0.1% JA8* ⁴ (L3D0) JA8 0-10V (JA8-10V)	4000K (4.0K) 4500K (4.5K)	Outdoor IP67* ⁸ (IP67)	Black (BK)	
		To calculate Lumens per Foot, multiply Efficacy by Wattage. Example: 2.5W x 100 Lm/W = 250 Lm/Ft	JA8 Hi-Lume 1% 2 Wire (JA8-LTEA) DMX-512* ⁵ (DMX) DALI* ⁶ (DALI) Leave Blank for Non-Dimming	Amber* ⁷ (A) Red* ⁷ (R) Green* ⁷ (G) Blue* ⁷ (B)			

*¹ Standard Finish: Natural Silver if left blank

*² (LTEA) 40 watt max Lutron Hi-Lume 1% 2 Wire #LTEA4U1UKL-CV240

*³ (L3DA) 40 watt max Lutron Hi-Lume 1% 3 Wire #L3DA4U1UKL-CV240

*⁴ (L3D0) 96 watt max Hi-Lume Premier 0.1% #L3D0-96W24V-U

*⁵ Consult third party DMX commissioner to modify at time of installation.

*⁶ DALI commissioning to be performed by a third party. CALI does not provide DALI commissioning.

*⁷ Amber, Red, Green, and Blue LEDs only available in 2.5W and 5.5W

*⁸ Run lengths required for Wet Location & IP67 products

CALIFORNIA ACCENT LIGHTING, INC.

2820 E. Gretta Lane, Anaheim, CA 92806

ph. 800.921.CALI (2254) | fx. 714.535.7902 | info@calilighting.com | calilighting.com

© CALI. All rights reserved. CALI reserves the right to make changes or withdraw specifications without prior notice.



ACCESSORIES (Sold Separately)



Power Connector Dry (20/2 Gauge Wire)
LLED8000-PC (33" Standard)
LLED8000-PC-X (X = Specify Length)

Note: Connector type subject to change without notice
Note: Connectors available with black or white jacket.
Click on image to see cut sheet for details.

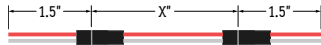

Continuous Connector Dry (20/2 Gauge Wire)
LLED8000-CC (3" Standard)
LLED8000-CC-X (X = Specify Length)

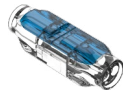

Wet Splice Connector
(LLED8000-SC-WET)

MOUNTING OPTIONS (Sold Separately)
Click image to view installation information

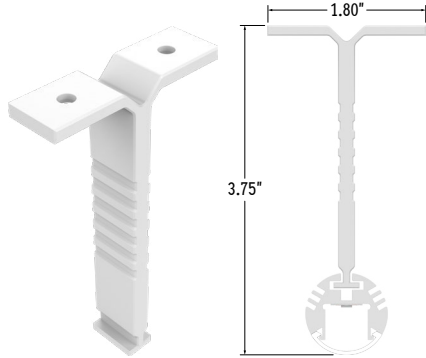

Mounting Bracket
(LLED8000-RPM-MB)

LAMP SPECIFICATIONS

LAMP NUMBER	CORRELATED COLOR TEMPERATURE	EFFICACY (LUMENS / WATT)	JA8	L70 LED LIFE
2.4K	2400K Incandescent White	90	Yes	60,000 hrs.
2.7K	2700K Warm White	101	Yes	60,000 hrs.
3.0K	3000K Warm White	100	Yes	60,000 hrs.
3.5K	3500K Neutral White	103	Yes	60,000 hrs.
4.0K	4000K Neutral White	105	Yes	60,000 hrs.
4.5K	4500K Neutral White	102	No	60,000 hrs.
R	Red (621nm)	70	No	40,000 hrs.
G	Green (525nm)	139	No	40,000 hrs.
B	Blue (470nm)	40	No	40,000 hrs.
A	Amber	128	No	40,000 hrs.

Consult factory for cooler white color temperatures.

PART NUMBER	WEIGHT	SPECIFY FINISH	SPECIFY LENGTH	SPECIFY QUANTITY	UNIT
LLED8000-CC-X*	Varies by Length				Each
LLED8000-PC-X*	Varies by Length				Each
LLED8000-SC-WET	0.009 lbs each	N/A	N/A		Each
LLED8000-RPM-MB	0.037 lbs		N/A		Each

*Leave blank for Standard option

DESIGN GUIDELINES

Individual Fixture

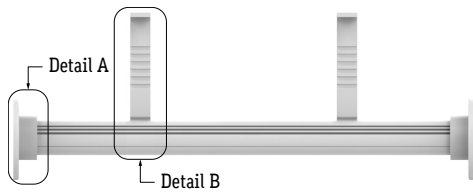

Continuous Run

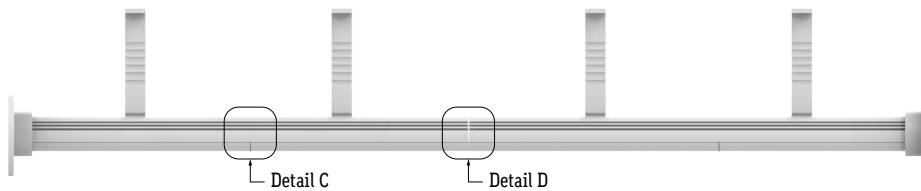

CALIFORNIA ACCENT LIGHTING, INC.

2820 E. Gretta Lane, Anaheim, CA 92806
ph. 800.921.CALI (2254) | fx. 714.535.7902 | info@calilighting.com | calilighting.com

© CALI. All rights reserved. CALI reserves the right to make changes or withdraw specifications without prior notice.

